



The perfect solutions for standard doors

TS Profil

TS 68

TS Kompakt

dormakaba 



TS Profil Door Closer

The ideal solution for standard doors

Key advantages

For Users

- Protection against abuse usage
- Optimum wall and door protection thanks to backcheck function

For Sellers:

- Ideal solution for standard doors
- One model for all door sizes

For Installers:

- Non-handed unit
- Quick and easy to install
- Fixes perfectly to all door types without the need for a mounting backplate

TS Profil is a door closer which can be universally used on all common door types and door sizes.

It is quick and easy to install – and does not require a mounting backplate.

Certified to ISO 9001

Technical data and Features		
Adjustable closing force		EN 2/3/4
Standard doors ≤ 1100 mm		●
External doors, opening outwards		●
Fire and smoke checks ≤ 1100 mm		-/●/●
Non-handed		●
Arm	Standard	●
	Slide channel	—
Closing speed adjustable at 2 separate valves	180° - 15°	●
	15° - 0°	●
Backcheck		●
Delayed action		—
Dimensions in mm	Length	207
	Overall depth	38.5
	Height	55.0
Hold-open		—
Weight in kg		1.4
Door closer tested to EN 1154		●
CE mark for construction products		●

Functions and options

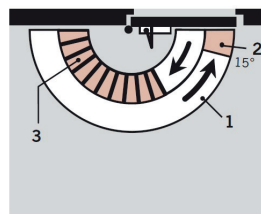

1 Adjustable closing speed in the range 180° – 15°

2 Adjustable closing speed in the range 15° – 0°

3 Backcheck

Standard equipment

Color	xx
Silver	01
White	11
(RAL 9016)	
Black	19
(RAL 9005)	

Door Closer TS Profil

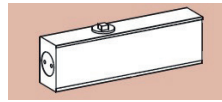

Size EN 2/3/4

Standard arm

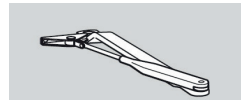

271122xx

Order number:

- - Closer with arm, complete
- # - Accessory

Applications and Fixing

Closing force settings

Door width	Size setting
≤ 850	Size 2
≤ 950	Size 3
≤ 1100	Size 4

The force setting is altered by selecting position of close on the door without changing existing fixing holes.

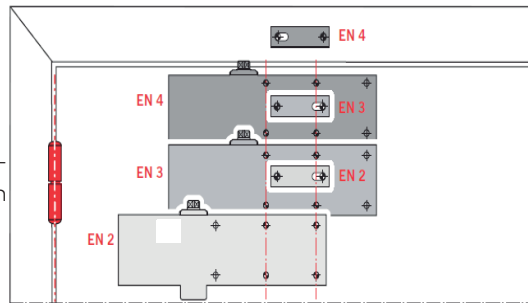

Rack and pinion door closer according to EN 1154, carries the CE mark, with selectable closing force, size EN 2, 3 and 4, adjustable closing speed in two independent ranges and backcheck.

Non-handed.

Available with:

- - standard arm

Accessories:

- - mounting backplate

Colors:

- - Silver
- - Black (similar to RAL9005)
- - White (similar to RAL9011)

Door - leaf fixing, Pull side

	EN2	EN 3	EN4
A	138	188	188
B	113,5	63,5	49,5
C	63	113	113

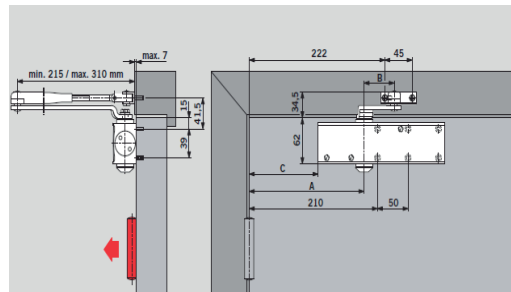

Frame fixing, Push side

	EN2	EN 3	EN4
A	170.0	170.0	250.0
B	59.0	43.0	43.0
C	96.5	96.5	176.5

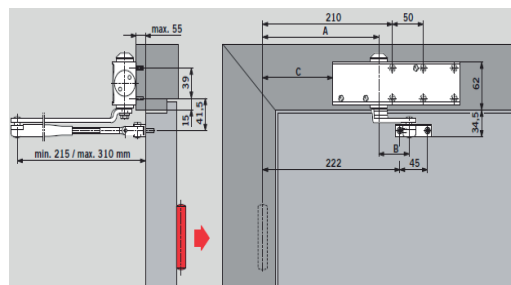

Mounting plate

For fitting the door closer to fire doors and to doors where direct fitting is not possible.

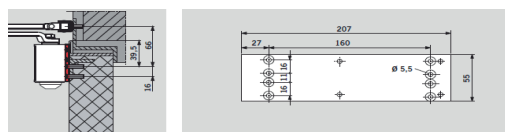



TS 68 Door Closer

The ideal low-cost solution for standard doors

Key advantages

For Users

- The door closer works with constant parameters independent of changes in ambient temperature
- Two valves for optimum closing speed and latching action

For Sellers:

- Low-cost solution for standard doors
- One model for all mounting positions

For Installers:

- Convenient and easy to adapt for both left and right handed doors
- Quick and easy to install
- Fixes perfectly to all door types without the need for a mounting backplate

TS 68 is a door closer which can be universally used on all common door types.

It is particularly quick and easy to install – and does not require additional mounting backplates.

Certified to ISO 9001

Technical data and Features

Selectable closing force (variable via from arm power shoe and templating)		EN 2/3/4
Door width ≤ 1100 mm		●
External doors, opening outwards		–
Non-handed		●
Arm	Standard	●
	Slide channel	–
Closing speed adjustable at 2 separate valves	180° - 15°	●
	15° - 0°	●
Backcheck		–
Delayed action		–
Dimensions in mm	Length	220
	Overall depth	45
	Height	53.5
Hold-open		Option
Weight in kg		1.4

Functions and options

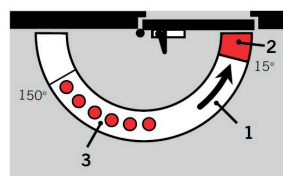

- 1 Adjustable closing speed in the range 180° – 15°
- 2 Adjustable closing speed in the range 15° – 0°
- 3 Hold-open range with hold-open arm model (optional extra)

Standard equipment and accessories

Color	xx
Silver	01
Dark brown	03
White	11
Black	19

Door Closer TS 68

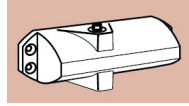

Size EN 2/3/4

Standard arm

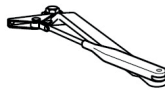

664001xx

Hold-open arm

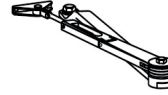

664002xx

Parallel arm bracket

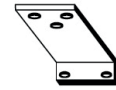

660005xx
#

Order number:

■ - Closer with arm, complete
- Accessory

Applications and Fixing

Closing force settings

Door width	Size setting
≤ 850	Size 2
≤ 950	Size 3
≤ 1100	Size 4

The TS 68's size setting is selected for the door width by moving the closer body and/or turning the arm power shoe.

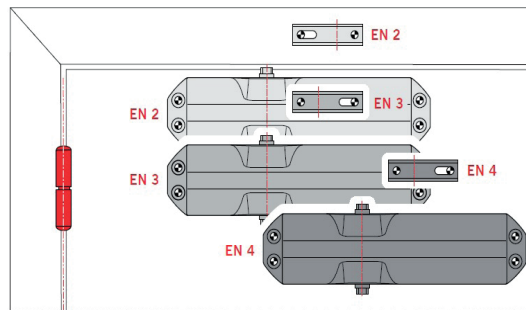

Rack and pinion door closer with selectable closing force, size EN 2, 3 and 4 and adjustable closing speed in two independent ranges.

Non-handed.

Available with:

- - standard arm
- - hold-open arm

Colors:

- - Silver
- - Dark brown
- - White (RAL 9016)
- - Black

Door - leaf fixing, Pull side

	EN2	EN 3	EN4
A	170	170	250
B	59	43	43
C	96	96	176
D	198.5	198.5	278.5
E	87	87	167

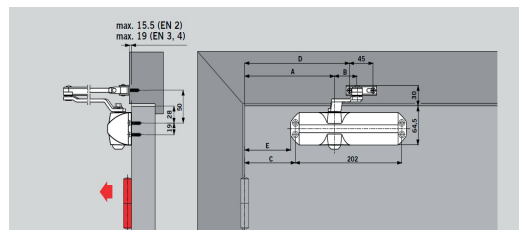

Frame fixing, Push side

	EN2	EN 3	EN4
A	170	170	250
B	59	43	43
C	96	96	176
D	198.5	198.5	278.5
E	87	87	167

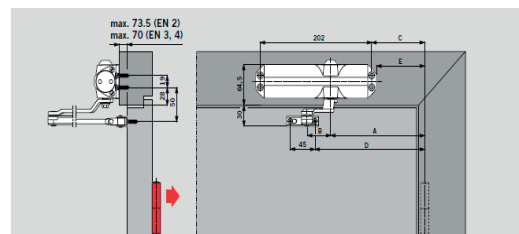

Parallel arm fixing, Push side

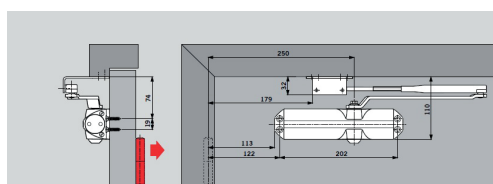



TS Kompakt Door Closer

The perfect solution for standard doors

Key advantages

For Users

- Two valves for optimum closing speed

For Sellers

- Ideal solution for standard doors
- Just one model for all door sizes to simplify stocking

For Installers:

- Non-handed unit
- Quick and easy to install
- Fixes perfectly to all door types without the need for a mounting backplate
- One model for all mounting positions

Technical data and Features

Adjustable closing force		EN 2/3/4
Standard doors ≤ 1100 mm		●
External doors, opening outwards		—
Fire and smoke check doors ≤ 1100 mm		—
Non-handed		●
Arm	Standard Slide channel	● —
Closing speed adjustable at 2 separate valves	180° - 15°	●
	15° - 0°	●
Backcheck		—
Delayed action		—
Dimensions in mm	Length	205.0
	Overall depth	46.0
	Height	40.0
Hold-open		Option
Weight in kg		1.2

Functions and options

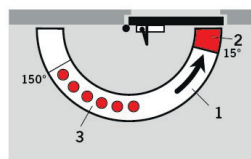

- 1 Adjustable closing speed in the range 180° – 15°
- 2 Adjustable closing speed in the range 15° – 0°
- 3 Hold-open range with hold-open arm model (optional extra)

TS Kompakt is a door closer which can be universally used on all common door types and sizes.

It is quick and easy to install – and does not require a mounting backplate.

Certified to ISO 9001

Standard equipment

Color	xx
Silver	01
Brown	03
White (RAL 9016)	11
Black (RAL 9005)	19

Order number:

- □ - Closer with arm, complete
- # - Accessory

Door Closer TS Kompakt

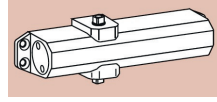

Size EN 2/3/4

Standard arm

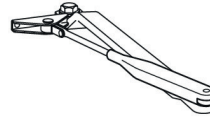

■ □ 670101xx

Hold-open arm

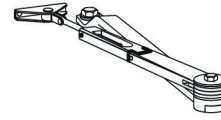

■ □ 670102xx

Applications and Fixing

Closing force settings

Door width	Size setting
≤ 850	Size 2
≤ 950	Size 3
≤ 1100	Size 4

The TS Kompakt size setting is selected for the door width by moving the closer body and/or turning the arm power shoe.

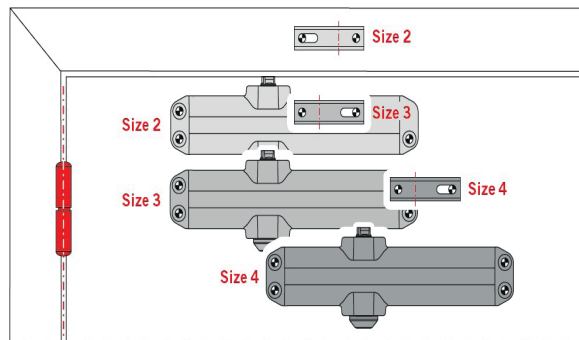

Rack and pinion door closer with selectable closing force, size EN 2, 3 and 4 and adjustable closing speed in two independent ranges.

Non-handed.

Available with:

- - standard arm
- - hold-open arm

Colors:

- - Silver
- - Brown
- - Black (similar to RAL9005)
- - White (similar to RAL9016)

Door - leaf fixing, Pull side

	EN2	EN 3	EN4
A	170.0	170.0	250.0
B	59.0	43.0	43.0
C	96.5	96.5	76.5
D	198.5	198.5	278.5
E	89.0	89.0	169.0

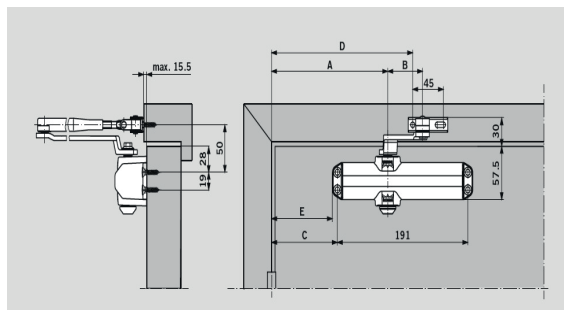

Frame fixing, Push side

	EN2	EN 3	EN4
A	170.0	170.0	250.0
B	9.0	43.0	43.0
C	96.5	96.5	176.5
D	198.5	198.5	278.5
E	89.0	89.0	69.0

