

HUSKY SOFT STOP

Fitting Instructions

HENDERSON

KIT AND DOOR SPECIFICATION

Kit Short Code	Operation Type	Min. Door Width*	Max. Door Width*	Door Thickness Range	Door Weight Range
SOFTH20	Dual Soft Stop	600mm	1150mm	20 - 50mm	10 - 20kg
SOFTH40	Dual Soft Stop	600mm	1150mm	20 - 50mm	20 - 40kg
SOFTH60	Dual Soft Stop	600mm	1150mm	20 - 50mm	40 - 60kg
SOFTH80	Dual Soft Stop	600mm	1150mm	20 - 50mm	60 - 80kg
SOFTH100	Single Soft Stop	600mm	1150mm	20 - 50mm	80 - 100kg

* Track length allowing

KIT CONTENTS - DUAL SOFT STOP (SOFTH20, SOFTH40, SOFTH60, SOFTH80)

Dual Soft Close Unit x1

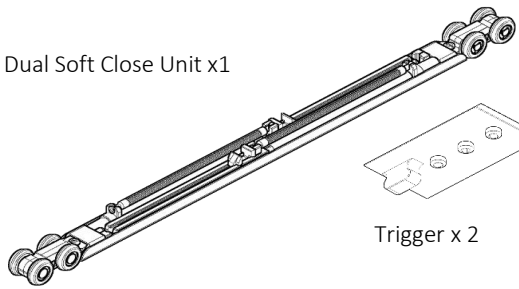

Trigger x 2



Apron Plate x 2



Strap Bolt x 2



Floor Guide x 1

Note: Depending on which kit has been purchased, track may or may not be included.

KIT CONTENTS - SINGLE SOFT STOP (SOFTH100)

Single Soft Close Unit x1

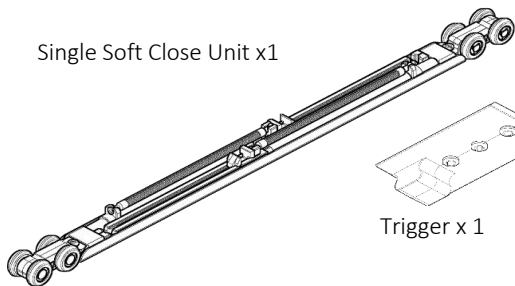

Trigger x 1



Apron Plate x 2



Strap Bolt x 2



Floor Guide x 1

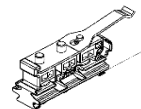

Clip Stop x 1

Note: Depending on which kit has been purchased, track may or may not be included.

TOOLS REQUIRED



Drill

With magnetic driver and posi bit

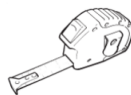

Tape

Measure



2mm Allen Key

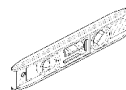

Spirit Level



13mm Spanner x2

STEP BY STEP FITTING INSTRUCTIONS

STEP 1: First measure the door and mark the centre point. Next, measure 231mm from the centre line to the edge of the door (in both directions) - this marks the position of the centre point of the apron plates. Attach the apron plates to the top of the door.

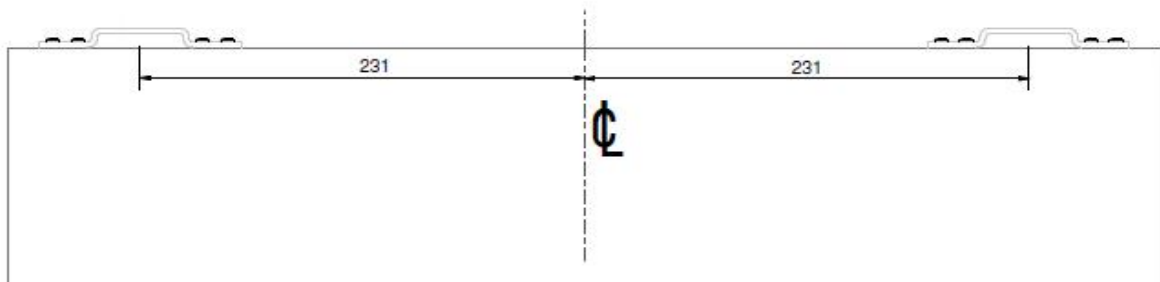

STEP 2: Route the bottom of the door, using the details shown below.

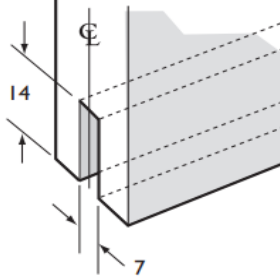

STEP 3: Tension the spring by pulling the triggers into the holding bay at the end of the stroke

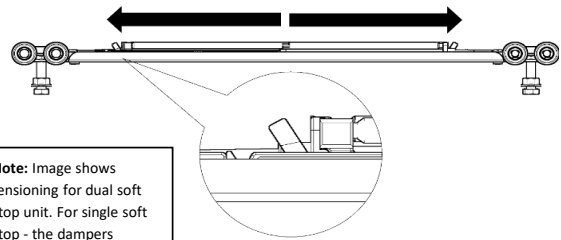

Note: Image shows tensioning for dual soft stop unit. For single soft stop - the dampers tension to one side.

STEP 4: Follow the diagram below to fix your track position.

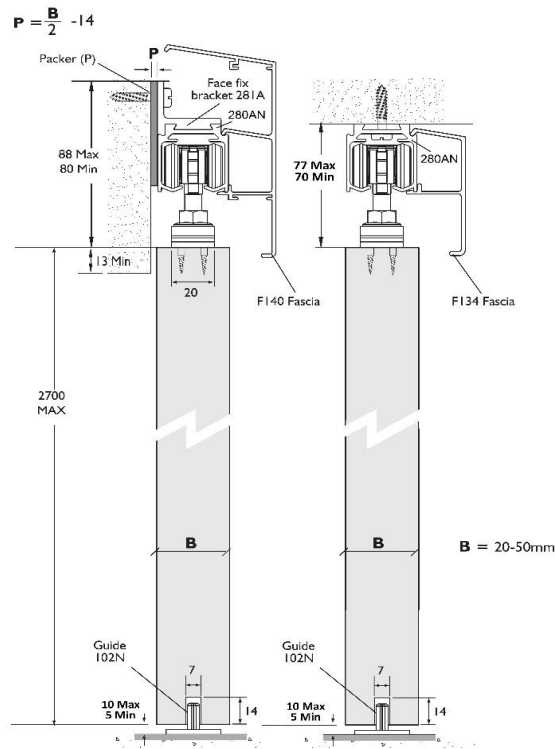

STEP 5: If face fixing the system, insert the fixing brackets into the top of the track. Then, using the edge of the opening as the centre point of the track, fix the track at the height identified in step 4.

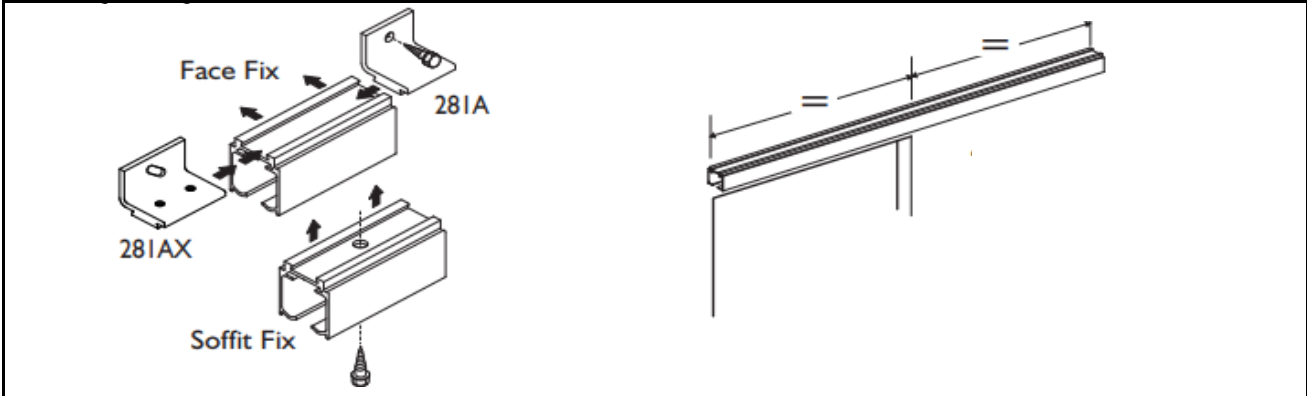

STEP 6: Fit the door guide at the edge of the opening.

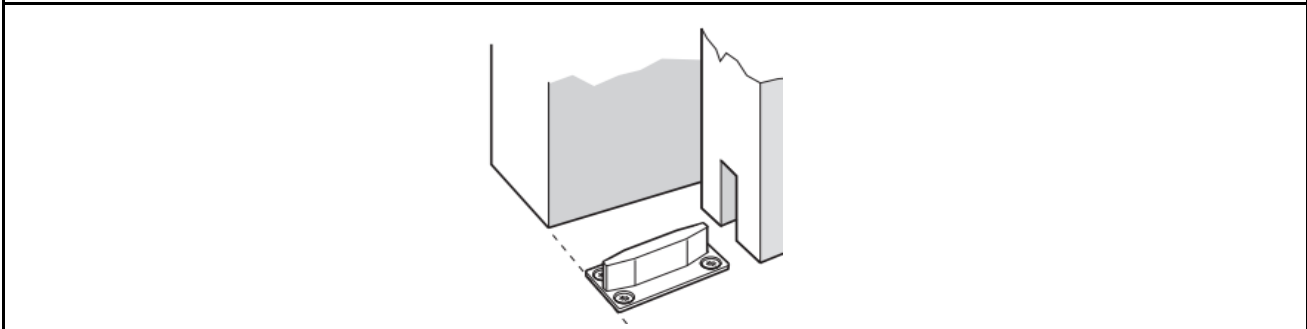

STEP 7: Slot the apron plates over the hangers and hang the door. Slide the door into the closed position over the opening. Once you have confirmed the position, measure 193mm in from the closing side hanger and make a mark on the track. Now, move the door into the open position and make another mark 193mm in from the opening side hanger. This marks your trigger positioning points.

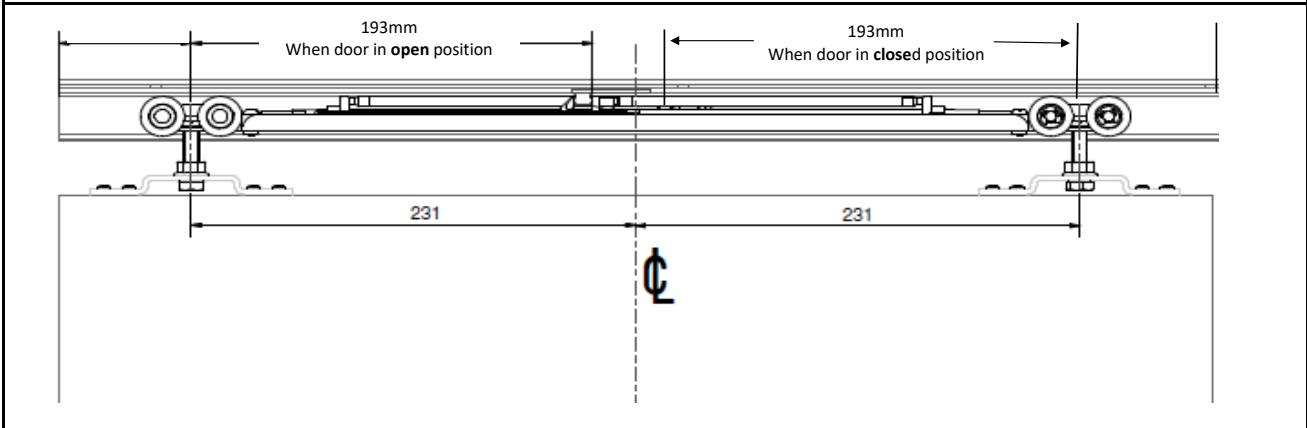

STEP 8: Centre the door and insert the triggers at either side into the correct position, securing into place with an allen key. The marks you created on the track in step 7 should line up exactly with the protruding part of the trigger.

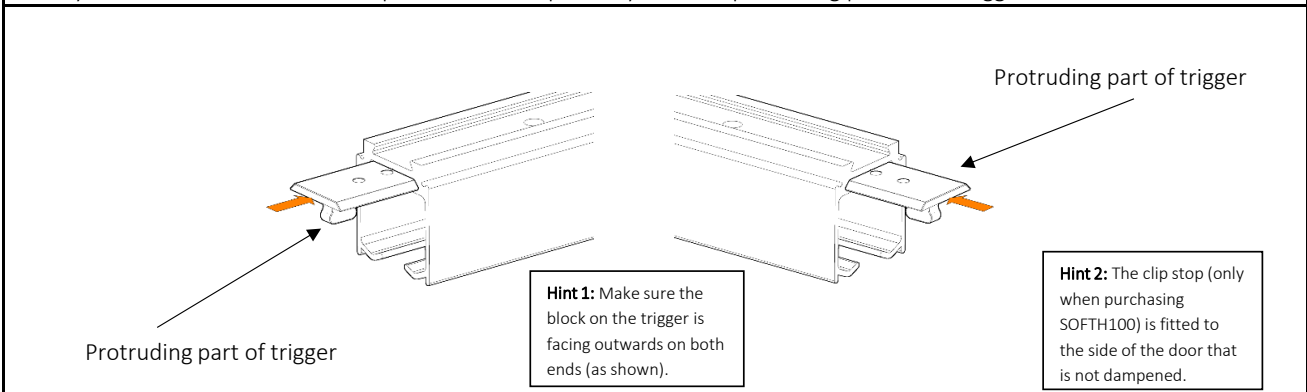

STEP 9: Finally adjust the height of the door and lock off. Ensure the door is adjusted parallel to the track and the wall. See illustration for indication of good and bad.

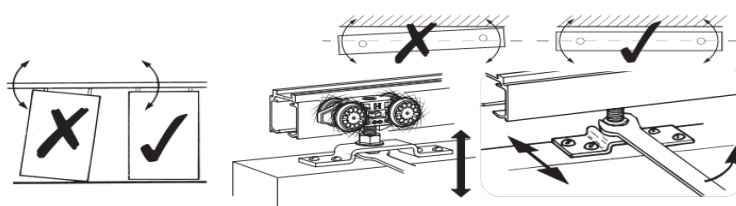

P C Henderson Ltd, Durham Road, Bowburn, Co. Durham, DH6 5NG

UK Sales

t: +44 (0) 191 377 7345

e: sales@pchenderson.com

w: www.pchenderson.com

International Sales

t: +44 (0) 191 377 7346

e: international@pchenderson.com

w: export.pchenderson.com

900020

LVL07

Oct-19