

DOOR LEVER HANDLE

1. Unscrew and remove end cap by hand.

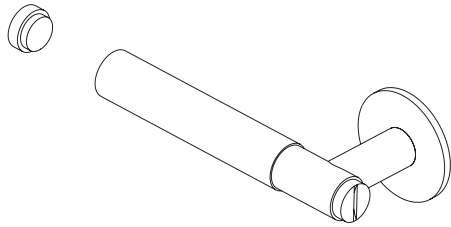

2. Insert crosshead (Phillips) screwdriver into end of handle and unscrew screw until handle can be removed.

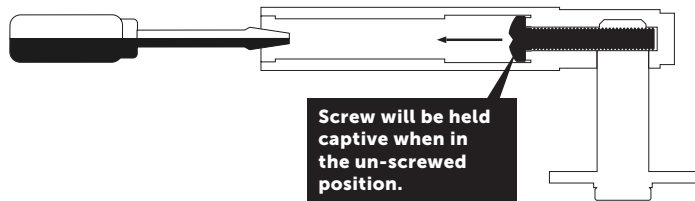

3. Remove handle from axle.

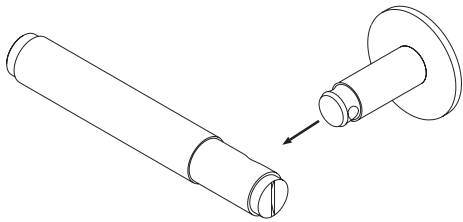

4. Pull back plate cover to gain access to screws.

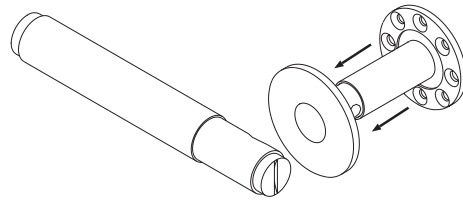

5. Fit handle using the square bar and screws provided. You might need to cut the screws to properly fit your door.

Tighten the handle at the inner engraved lines for a 35 mm door, and the outer lines for a 44 mm door.

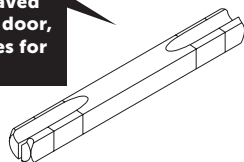

Fit through bolts with the bolt nut.

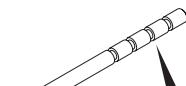

Adjust length by cutting the screw.

6. Fit the screws as the diagram shows. Fit wood screws is needed.

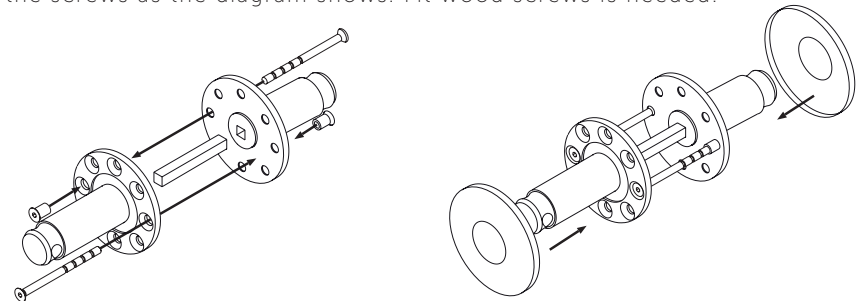

7. Reverse procedure to fix back together. Tighten the screw under the bar with a cross head screwdriver to straighten the handle.

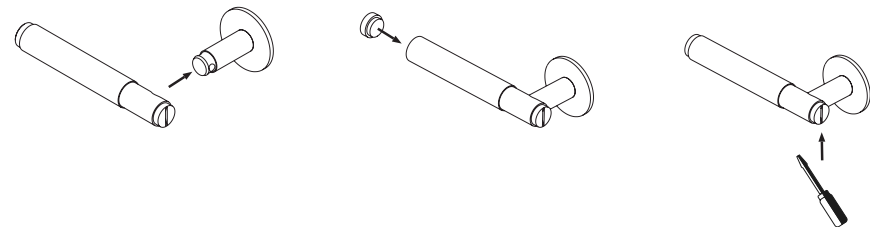

BUSTERANDPUNCH.COM

BUSTER + PUNCH

HARDWARE
DOOR LEVER HANDLE
38 MM

SKU# UK-LH-S-38** UK-LH-U-38**

Contents

- 4x Wood screws
- 1x Square bar
- 2x Through bolts + nuts

CARE INSTRUCTIONS

Use mild detergent and soft damp cloth



DOOR LEVER HANDLE

1. Unscrew and remove end cap by hand.

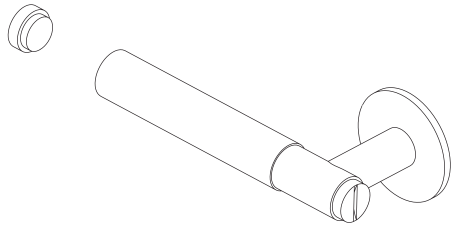

2. Insert crosshead (Phillips) screwdriver into end of handle and unscrew screw until handle can be removed.

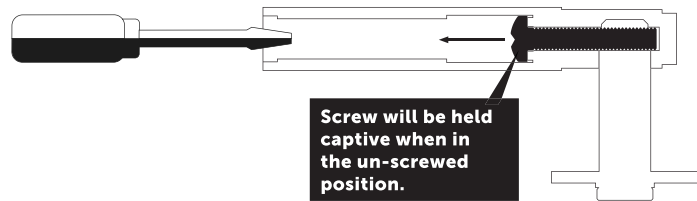

3. Remove handle from axle.

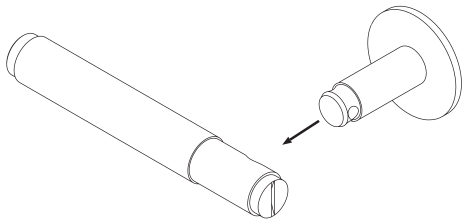

4. Pull back plate cover to gain access to screws.

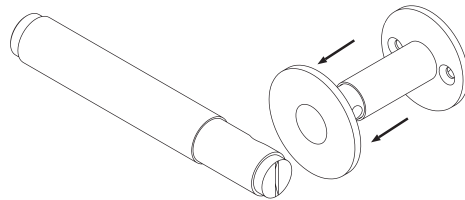

5. Fit handle using the square bar and screws provided. You might need to cut the screws to properly fit your door.

Tighten the handle at the inner engraved lines for a 35 mm door, and the outer lines for a 44 mm door.

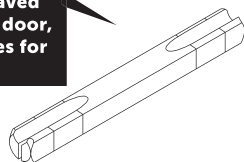

Fit through bolts with the bolt nut.

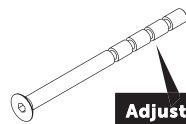

Adjust length by cutting the screw.



BUSTERANDPUNCH.COM

BUSTER + PUNCH

HARDWARE
DOOR LEVER HANDLE
30 MM UNSPRUNG

SKU# UK-LH-S-30**

Contents

- 1x Square bar
- 2x Through bolts + nuts

CARE INSTRUCTIONS

Use mild detergent and soft damp cloth



6. Fit the screws as the diagram shows.

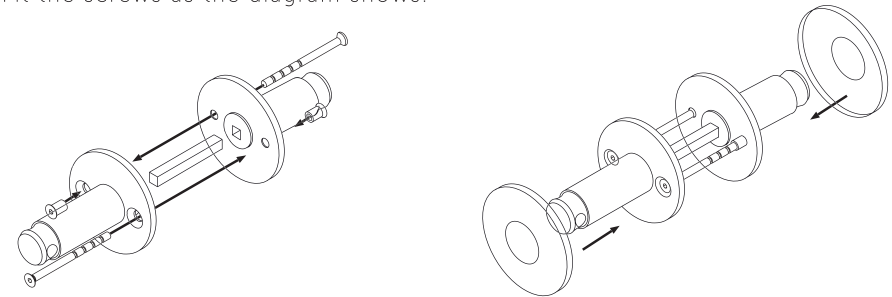

7. Reverse procedure to fix back together. Tighten the screw under the bar with a cross head screwdriver to straighten the handle.

